



## High Pressure Equipment

### High Pressure Valves, Fittings and Tubing 30,000, 40,000 and 60,000 psi service

High Pressure Equipment Company has developed a line of High Pressure products to assure safe and easy plumbing for 30,000, 40,000 and 60,000 psi. These needle valves, fittings, line filters, check valves, safety heads, rupture discs, anti-vibration gland assemblies, tubing and nipples are engineered to the highest standards of repeatable quality. The reliable performance of these products has made HiP one of the world's leading suppliers of elevated pressure components.

High Pressure components use a coned-and-threaded connection which accommodates the high temperatures and pressures common in these applications. High Pressure valves are available in various tubing sizes and with body designs to satisfy widely varied requirements. A line of fittings is available to facilitate adapting to Taper Seal, Medium Pressure, or other High Pressure threaded pipe systems.



<b>Index</b>	Page
30,000 psi Valves . . . . .	4.2-4.3
40,000 psi Valves . . . . .	4.3.5-4.3.6
60,000 psi Valves . . . . .	4.4-4.5
Fittings . . . . .	4.6
Unions, Bulkheads & Caps . . . . .	4.7
Line Filters & Check Valves . . . . .	4.8-4.9
Rupture Discs . . . . .	4.9
Safety Heads . . . . .	4.10
Anti-Vibration Gland Assemblies . . . . .	4.11
Tubing . . . . .	4.12
Coned & Threaded Nipples . . . . .	4.12
Connection Details . . . . .	4.A
	Appendix



## High Pressure Equipment

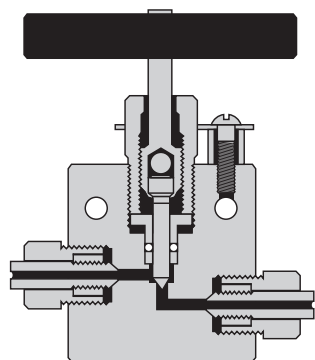

HF2 ( $\frac{1}{8}$ "

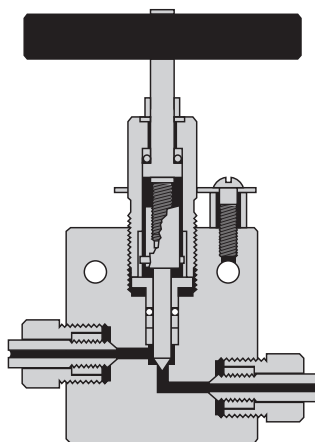

HF4 ( $\frac{1}{4}$ "), HF6 ( $\frac{3}{8}$ " and HF9 ( $\frac{9}{16}$ "

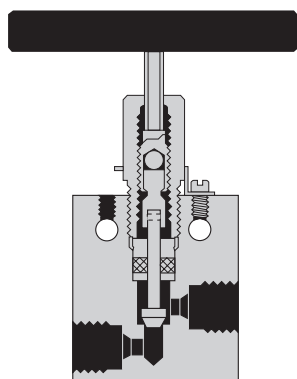

HF16 (1"

### 30,000 psi High Pressure Valves

**High Pressure (coned & threaded)** type connections for  $\frac{1}{8}$ ",  $\frac{1}{4}$ ",  $\frac{3}{8}$ ",  $\frac{9}{16}$ " and 1" O.D. tubing.

**Non-rotating tip stems** are standard for on-off service and insure long life on valve seats. Regulating tip stems are available for all valves at no additional cost, add - REG to part number.

**Glands and collars** for tubing are supplied with each valve unless otherwise requested (glands and collars shown on pages 4.8 and 4.A).

**Materials** include high tensile type 316 stainless steel bodies and hardened 17-4PH stainless steel lower section stems.

**Packing** is Teflon (450°F) standard with optional Viton (350°F), BUNA-N (200°F) and Grafoil (800°F) available at no additional cost.

**Air operators** for remote control operation are available for all valves. (Select required valve and add "HIPCO". Refer to section 7.0 for additional data).

**High temperatures** can be accommodated using extended stuffing boxes (see page 6.4). These are available for all sizes except  $\frac{1}{8}$ " tubing. To order, add suffix -HT to standard valve catalog number.

#### Valve Features

- Non-rotating stem tips
- Packing below stem threads
- Type 316 ss high tensile bodies
- Positive gland lock device
- No stem adjustment needed
- Black T-handles or choice of 4 colors
- Tube sizes  $\frac{1}{8}$ " through  $\frac{9}{16}$ "

# 30,000 psi High Pressure Valves

## Two Way Straight Valves

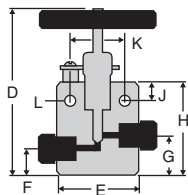

Tubing	Catalog No.	psi	Connection	Orifice	D	E	F	G	H	J	K	L	Thickness
1/8" O.D.	30-11HF2	30,000	HF2	1/16"	3 3/4"	1 1/2"	1 1/16"	1 5/16"	1 13/16"	5/16"	7/8"	9/64"	3/4"
1/4" O.D.	30-11HF4	30,000	HF4	3/32"	5 3/16"	2"	5/8"	1"	2 7/16"	1/2"	1 3/8"	7/32"	1"
3/8" O.D.	30-11HF6	30,000	HF6	1/8"	5 9/16"	2"	5/8"	1"	2 7/16"	1/2"	1 3/8"	7/32"	1"
9/16" O.D.	30-11HF9	30,000	HF9	1/8"	5 5/8"	2 5/8"	1"	1 7/16"	2 7/8"	1/2"	1 3/8"	7/32"	1 1/2"
1" O.D.	30-11HF16	30,000	HF16	7/16"	8 27/64"	4 1/8"	1 5/16"	1 11/16"	4 7/16"	1 1/8"	2 1/2"	9/16"	1 3/4"

## Two Way Angle Valves

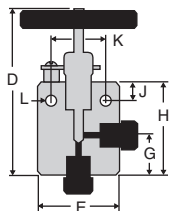

Tubing	Catalog No.	psi	Connection	Orifice	D	E	F	G	H	J	K	L	Thickness
1/8" O.D.	30-12HF2	30,000	HF2	1/16"	3 3/4"	1 1/2"	—	1 5/16"	1 13/16"	5/16"	7/8"	9/64"	3/4"
1/4" O.D.	30-12HF4	30,000	HF4	3/32"	5 3/16"	2"	—	1"	2 7/16"	1/2"	1 3/8"	7/32"	1"
3/8" O.D.	30-12HF6	30,000	HF6	1/8"	5 9/16"	2"	—	1 3/8"	2 13/16"	1/2"	1 3/8"	7/32"	1"
9/16" O.D.	30-12HF9	30,000	HF9	1/8"	5 5/8"	2 5/8"	—	1 7/16"	2 7/8"	1/2"	1 3/8"	7/32"	1 1/2"
1" O.D.	30-12HF16	30,000	HF16	7/16"	9 11/32"	4 1/8"	—	2 3/8"	5 1/8"	1 1/8"	2 1/2"	9/16"	1 3/4"

## Three Way Valves / Two Pressure Connections

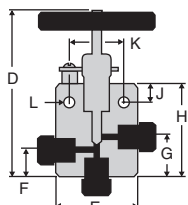

Tubing	Catalog No.	psi	Connection	Orifice	D	E	F	G	H	J	K	L	Thickness
1/8" O.D.	30-13HF2	30,000	HF2	1/16"	3 3/4"	1 1/2"	1 1/16"	1 5/16"	1 13/16"	5/16"	7/8"	9/64"	3/4"
1/4" O.D.	30-13HF4	30,000	HF4	3/32"	5 3/16"	2"	5/8"	1"	2 7/16"	1/2"	1 3/8"	7/32"	1"
3/8" O.D.	30-13HF6	30,000	HF6	1/8"	5 9/16"	2"	1"	1 3/8"	2 13/16"	1/2"	1 3/8"	7/32"	1"
9/16" O.D.	30-13HF9	30,000	HF9	1/8"	6 1/16"	2 5/8"	1 7/16"	1 7/8"	3 5/16"	1/2"	1 3/8"	7/32"	1 1/2"
1" O.D.	30-13HF16	30,000	HF16	7/16"	9 23/32"	4 1/8"	2 3/8"	2 13/16"	5 9/16"	1 1/8"	2 1/2"	9/16"	1 3/4"

## Three Way Valves / One Pressure Connection

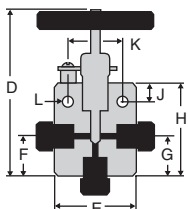

Tubing	Catalog No.	psi	Connection	Orifice	D	E	F	G	H	J	K	L	Thickness
1/8" O.D.	30-14HF2	30,000	HF2	1/16"	3 3/4"	1 1/2"	1 5/16"	1 5/16"	1 13/16"	5/16"	7/8"	9/64"	3/4"
1/4" O.D.	30-14HF4	30,000	HF4	3/32"	5 3/16"	2"	1"	1"	2 7/16"	1/2"	1 3/8"	7/32"	1"
3/8" O.D.	30-14HF6	30,000	HF6	1/8"	5 9/16"	2"	2"	1 7/16"	2 13/16"	1/2"	1 3/8"	7/32"	1"
9/16" O.D.	30-14HF9	30,000	HF9	1/8"	5 5/8"	2 5/8"	2 3/16"	1 7/16"	2 7/8"	1/2"	1 3/8"	7/32"	1 1/2"
1" O.D.	30-14HF16	30,000	HF16	7/16"	9 11/32"	4 1/8"	2 3/8"	2 3/8"	5 1/8"	1 1/8"	2 1/2"	9/16"	1 3/4"

## Three Way / Two Stem Connection Valves

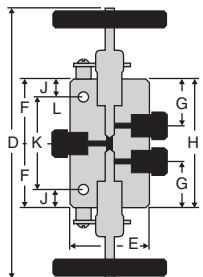

Tubing	Catalog No.	psi	Connection	Orifice	D	E	F	G	H	J	K	L	Thickness
1/8" O.D.	30-15HF2	30,000	HF2	1/16"	5 1/4"	1 1/2"	1 5/16"	7/8"	2 1/2"	5/16"	1 7/8"	9/64"	3/4"
1/4" O.D.	30-15HF4	30,000	HF4	3/32"	9 1/4"	2"	1"	1 7/16"	3 3/4"	1/2"	2 3/4"	7/32"	1"
3/8" O.D.	30-15HF6	30,000	HF6	1/8"	9 1/2"	2"	2"	1 7/16"	4"	1/2"	3"	7/32"	1"
9/16" O.D.	30-15HF9	30,000	HF9	1/8"	9 7/8"	2 5/8"	2 3/16"	1 7/16"	4 3/8"	1/2"	3 3/8"	7/32"	1 1/2"
1" O.D.	30-15HF16	30,000	HF16	7/16"	11 13/16"	4 1/8"	3 3/8"	2 3/4"	7 3/4"	1 1/8"	2 1/2"	9/16"	1 3/4"

## Replaceable Seat Valves

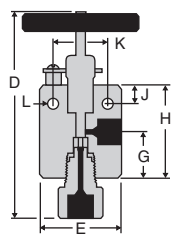

Tubing	Catalog No.	psi	Connection	Orifice	D	E	F	G	H	J	K	L	Thickness
1/4" O.D.	30-12HF4-R	30,000	HF4	3/32"	6"	2"	—	1"	2 7/16"	1/2"	1 3/8"	7/32"	1"
3/8" O.D.	30-12HF6-R	30,000	HF6	1/8"	6 5/8"	2"	—	1 3/8"	2 13/16"	1/2"	1 3/8"	7/32"	1"
9/16" O.D.	30-12HF9-R	30,000	HF9	1/8"	6 13/16"	2 5/8"	—	1 7/16"	2 7/8"	1/2"	1 3/8"	7/32"	1 1/2"
1" O.D.	30-12HF16-R	30,000	HF16	7/16"	10 7/8"	4 1/8"	—	2 3/8"	5 1/8"	1 1/8"	2 1/2"	9/16"	1 3/4"



## High Pressure Equipment

### 40,000 psi High Pressure Valves

**High Pressure (coned & threaded)** type connections for  $\frac{9}{16}$ " O.D. tubing.

**Non-rotating tip stems** are standard for on-off service and insure long life on valve seats. Regulating tip stems are available for all valves at no additional cost, add - REG to part number.

**Glands and collars** for tubing are supplied with each valve unless otherwise requested (glands and collars shown on pages 4.8 and 4.A).

**Materials** include high tensile type 316 stainless steel bodies and hardened 17-4PH stainless steel lower section stems.

**Packing set** consists of multiple Teflon packing with nylon back up, with optional Viton (350°F), BUNA-N (200°F) and Grafoil (800°F) available at no additional cost.

**Air operators** for remote control operation are available for all valves. (Select required valve and add "HIPCO". Refer to section 7.0 for additional data).

**High temperatures** can be accommodated using extended stuffing boxes (see page 6.4).

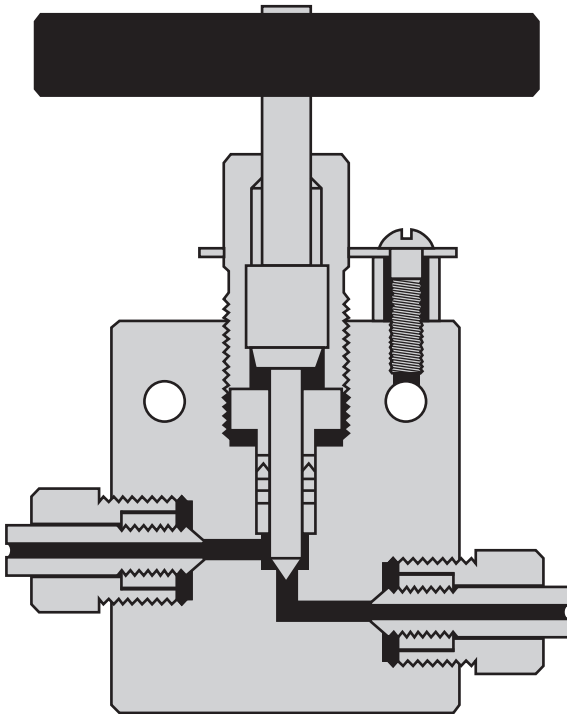

#### Valve Features

- Non-rotating stem tips
- Packing below stem threads
- Type 316 ss high tensile bodies
- Positive gland lock device
- No stem adjustment needed
- Black T-handles or choice of 4 colors

# 40,000 psi High Pressure Valves

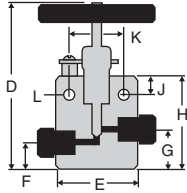

## Two Way Straight Valves

Tubing	Catalog No.	psi	Connection	Orifice	D	E	F	G	H	J	K	L	Thickness
9/16" O.D.	40-11HF9	40,000	HF9	1/8"	5 5/8"	2 5/8"	1"	1 7/16"	2 7/8"	1/2"	1 5/8"	7/32"	1 1/2"

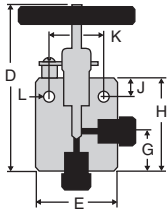

## Two Way Angle Valves

Tubing	Catalog No.	psi	Connection	Orifice	D	E	F	G	H	J	K	L	Thickness
9/16" O.D.	40-12HF9	40,000	HF9	1/8"	5 5/8"	2 5/8"	—	1 7/16"	2 7/8"	1/2"	1 5/8"	7/32"	1 1/2"

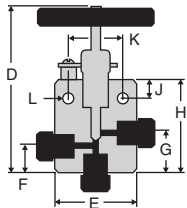

## Three Way Valves / Two Pressure Connections

Tubing	Catalog No.	psi	Connection	Orifice	D	E	F	G	H	J	K	L	Thickness
9/16" O.D.	40-13HF9	40,000	HF9	1/8"	6 1/16"	2 5/8"	1 7/16"	1 7/16"	3 5/16"	1/2"	1 5/8"	7/32"	1 1/2"

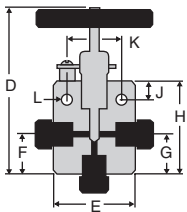

## Three Way Valves / One Pressure Connection

Tubing	Catalog No.	psi	Connection	Orifice	D	E	F	G	H	J	K	L	Thickness
9/16" O.D.	40-14HF9	40,000	HF9	1/8"	5 5/8"	2 5/8"	1 7/16"	1 7/16"	2 7/8"	1/2"	1 5/8"	7/32"	1 1/2"

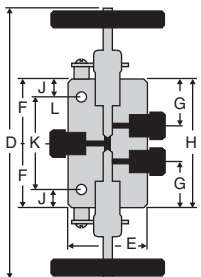

## Three Way / Two Stem Connection Valves

Tubing	Catalog No.	psi	Connection	Orifice	D	E	F	G	H	J	K	L	Thickness
9/16" O.D.	40-15HF9	40,000	HF9	1/8"	9 7/8"	2 5/8"	2 3/16"	1 7/16"	4 3/8"	1/2"	3 3/8"	7/32"	1 1/2"

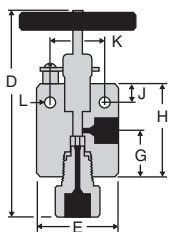

## Replaceable Seat Valves

Tubing	Catalog No.	psi	Connection	Orifice	D	E	F	G	H	J	K	L	Thickness
9/16" O.D.	40-12HF9-R	40,000	HF9	1/8"	6 3/8"	2 5/8"	—	1 7/16"	2 7/8"	1/2"	1 5/8"	7/32"	1 1/2"



## High Pressure Equipment

### 60,000 psi High Pressure Valves

**High Pressure (coned & threaded)** type connections for  $\frac{1}{8}$ ",  $\frac{1}{4}$ ",  $\frac{3}{8}$ ",  $\frac{9}{16}$ " and 1" O.D. tubing.

**Non-rotating tip stems** are standard for on-off service and insure long life on valve seats. Regulating tip stems are available for all valves at no additional cost, add - REG to part number.

**Glands and collars** for tubing are supplied with each valve unless otherwise requested (glands and collars shown on pages 4.8 and 4.A).

**Materials** include high tensile type 316 stainless steel bodies and hardened 17-4PH stainless steel lower section stems.

**Packing set** consists of multiple Teflon packing with nylon back up, with optional Viton (350°F), BUNA-N (200°F) and Grafoil (800°F) available at no additional cost.

**Air operators** for remote control operation are available for all valves. (Select required valve and add "HIPCO". Refer to section 7.0 for additional data).

**High temperatures** can be accommodated using extended stuffing boxes (see page 6.4). These are available for all sizes except  $\frac{1}{8}$ " tubing.

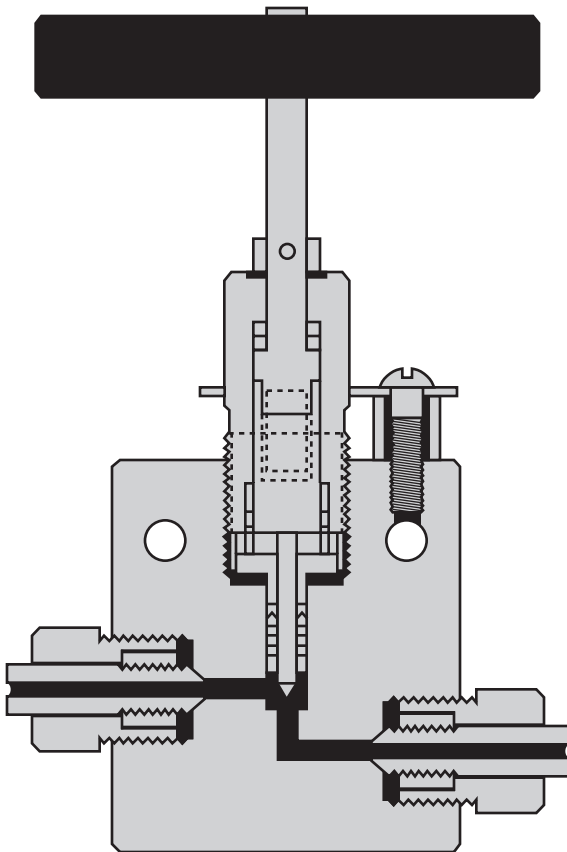

#### Valve Features

- Non-rotating stem tips
- Packing below stem threads
- Type 316 ss high tensile bodies
- Positive gland lock device
- No stem adjustment needed
- Black T-handles or choice of 4 colors
- Tube sizes  $\frac{1}{8}$ " through  $\frac{9}{16}$ "



## Two Way Straight Valves

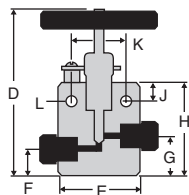

Tube	Catalog No.	psi	Connection	Orifice	D	E	F	G	H	J	K	L	Thickness
1/8" O.D.	60-11HF2	60,000	HF2	1/16"	5 3/16"	2"	5/8"	1 5/16"	2 7/16"	1/2"	1 3/8"	7/32"	1"
1/4" O.D.	60-11HF4	60,000	HF4	1/16"	5 3/16"	2"	5/8"	1"	2 7/16"	1/2"	1 3/8"	7/32"	1"
3/8" O.D.	60-11HF6	60,000	HF6	1/16"	5 3/16"	2"	5/8"	1"	2 7/16"	1/2"	1 3/8"	7/32"	1"
9/16" O.D.	60-11HF9	60,000	HF9	1/16"	5 5/8"	2 5/8"	1"	1 7/16"	2 7/8"	1/2"	1 3/8"	7/32"	1 1/2"

## Two Way Angle Valves

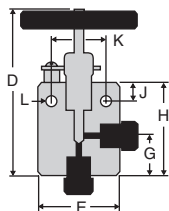

Tube	Catalog No.	psi	Connection	Orifice	D	E	F	G	H	J	K	L	Thickness
1/8" O.D.	60-12HF2	60,000	HF2	1/16"	5 3/16"	2"	-	1"	2 7/16"	1/2"	1 3/8"	7/32"	1"
1/4" O.D.	60-12HF4	60,000	HF4	1/16"	5 3/16"	2"	-	1"	2 7/16"	1/2"	1 3/8"	7/32"	1"
3/8" O.D.	60-12HF6	60,000	HF6	1/16"	5 3/16"	2"	-	1 3/8"	2 13/16"	1/2"	1 3/8"	7/32"	1"
9/16" O.D.	60-12HF9	60,000	HF9	1/16"	5 5/8"	2 5/8"	-	1 7/16"	2 7/8"	1/2"	1 3/8"	7/32"	1 1/2"

## Three Way Valves / Two Pressure Connections

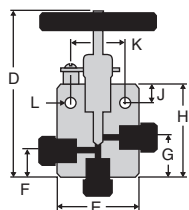

Tube	Catalog No.	psi	Connection	Orifice	D	E	F	G	H	J	K	L	Thickness
1/8" O.D.	60-13HF2	60,000	HF2	1/16"	5 3/16"	2"	5/8"	1"	2 7/16"	1/2"	1 3/8"	7/32"	1"
1/4" O.D.	60-13HF4	60,000	HF4	1/16"	5 3/16"	2"	5/8"	1"	2 7/16"	1/2"	1 3/8"	7/32"	1"
3/8" O.D.	60-13HF6	60,000	HF6	1/16"	5 3/16"	2"	1"	1 3/8"	2 13/16"	1/2"	1 3/8"	7/32"	1"
9/16" O.D.	60-13HF9	60,000	HF9	1/16"	6 1/16"	2 5/8"	1 7/16"	1 7/8"	3 5/16"	1/2"	1 3/8"	7/32"	1 1/2"

## Three Way Valves / One Pressure Connection

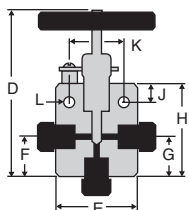

Tube	Catalog No.	psi	Connection	Orifice	D	E	F	G	H	J	K	L	Thickness
1/8" O.D.	60-14HF2	60,000	HF2	1/16"	5 3/16"	2"	7/8"	1 1/2"	2 7/16"	1/2"	1 3/8"	7/32"	1"
1/4" O.D.	60-14HF4	60,000	HF4	1/16"	5 3/16"	2"	1"	1"	2 7/16"	1/2"	1 3/8"	7/32"	1"
3/8" O.D.	60-14HF6	60,000	HF6	1/16"	5 3/16"	2"	1 3/8"	1 3/8"	2 13/16"	1/2"	1 3/8"	7/32"	1"
9/16" O.D.	60-14HF9	60,000	HF9	1/16"	5 5/8"	2 5/8"	1 7/16"	1 7/8"	2 7/8"	1/2"	1 3/8"	7/32"	1 1/2"

## Three Way / Two Stem Connection Valves

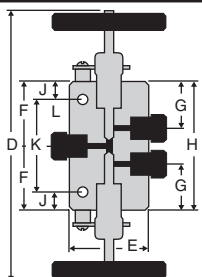

Tube	Catalog No.	psi	Connection	Orifice	D	E	F	G	H	J	K	L	Thickness
1/8" O.D.	60-15HF2	60,000	HF2	1/16"	9 1/4"	2"	1 7/8"	1 7/16"	3 3/4"	1/2"	2 3/4"	7/32"	1"
1/4" O.D.	60-15HF4	60,000	HF4	1/16"	9 1/4"	2"	1 7/8"	1 7/16"	3 3/4"	1/2"	2 3/4"	7/32"	1"
3/8" O.D.	60-15HF6	60,000	HF6	1/16"	9 1/2"	2"	2"	1 7/16"	4"	1/2"	3"	7/32"	1"
9/16" O.D.	60-15HF9	60,000	HF9	1/16"	9 7/8"	2 5/8"	2 3/16"	1 7/16"	4 3/8"	1/2"	3 3/8"	7/32"	1 1/2"

## Replaceable Seat Valves

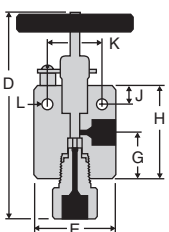

Tube	Catalog No.	psi	Connection	Orifice	D	E	F	G	H	J	K	L	Thickness
1/4" O.D.	60-12HF4-R	60,000	HF4	1/16"	6"	2"	-	1"	2 7/16"	1/2"	1 3/8"	7/32"	1"
3/8" O.D.	60-12HF6-R	60,000	HF6	1/16"	6 5/8"	2"	-	1 3/8"	2 13/16"	1/2"	1 3/8"	7/32"	1"
9/16" O.D.	60-12HF9-R	60,000	HF9	1/16"	6 13/16"	2 5/8"	-	1 7/16"	2 7/8"	1/2"	1 3/8"	7/32"	1 1/2"



## High Pressure Equipment

### Glands/Sleeves/Plugs/Elbows/Tees/Crosses

A complete range of elbows, tees, and crosses is available for all of the tubing connection sizes. Material is high tensile 316 stainless steel. Standard tubing glands and collars are provided unless otherwise specified.

#### Connection Components

Catalog No.	Tube Size	Gland	Catalog No.	Tube Size	Collar	Catalog No.	Tube Size	Plug
60-2HM2	1/8"		60-2H2	1/8"		60-7HM2	1/8"	
60-2HM4	1/4"		60-2H4	1/4"		60-7HM4	1/4"	
60-2HM6	3/8"		60-2H6	3/8"		60-7HM6	3/8"	
60-2HM9	9/16"		60-2H9	9/16"		60-7HM9	9/16"	
40-2HM9	9/16"		40-2H9	9/16"		40-7HM9	9/16"	
30-2HM16	1"		30-2H16	1"		30-7HM16	1"	

#### High Pressure Elbows

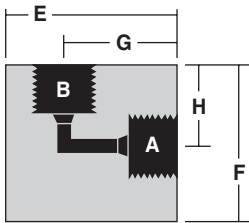

Catalog No.	Pressure Rating psi	Connections	A-B	E	F	G	H	Thickness
60-22HF2	60,000	1/8" O.D. TUBE	HF2	1 1/8"	1 1/8"	3/4"	3/4"	3/4"
60-22HF4	60,000	1/4" O.D. TUBE	HF4	1 3/8"	1 1/2"	7/8"	1"	1"
60-22HF6	60,000	3/8" O.D. TUBE	HF6	1 3/4"	1 1/2"	1 1/4"	1"	1"
60-22HF9	60,000	9/16" O.D. TUBE	HF9	2 5/8"	1 7/8"	1 7/8"	1 1/8"	1 1/2"
40-22HF9	40,000	9/16" O.D. TUBE	HF9	2 5/8"	1 7/8"	1 7/8"	1 1/8"	1 1/2"
30-22HF16	30,000	1" O.D. TUBE	HF16	3"	3"	2 1/16"	2 1/16"	1 3/4"

#### High Pressure Tees

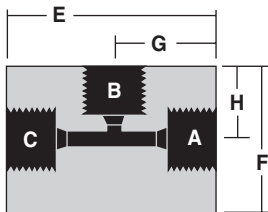

Catalog No.	Pressure Rating psi	Connections	A-B-C	E	F	G	H	Thickness
60-23HF2	60,000	1/8" O.D. TUBE	HF2	1 1/2"	1 1/8"	3/4"	3/4"	3/4"
60-23HF4	60,000	1/4" O.D. TUBE	HF4	2"	1 3/8"	1"	7/8"	1"
60-23HF6	60,000	3/8" O.D. TUBE	HF6	2"	1 9/16"	1"	1 1/16"	1"
60-23HF9	60,000	9/16" O.D. TUBE	HF9	2 5/8"	2 1/8"	1 5/16"	1 3/8"	1 1/2"
40-23HF9	40,000	9/16" O.D. TUBE	HF9	2 5/8"	2 1/8"	1 5/16"	1 3/8"	1 1/2"
30-23HF16	30,000	1" O.D. TUBE	HF16	4 1/8"	3"	2 1/16"	2 1/16"	1 3/4"

#### High Pressure Crosses

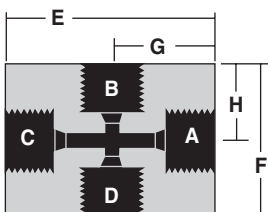

Catalog No.	Pressure Rating psi	Connections	A-B-C-D	E	F	G	H	Thickness
60-24HF2	60,000	1/8" O.D. TUBE	HF2	1 1/2"	1 1/2"	3/4"	3/4"	3/4"
60-24HF4	60,000	1/4" O.D. TUBE	HF4	2"	1 1/2"	1"	3/4"	1"
60-24HF6	60,000	3/8" O.D. TUBE	HF6	2 1/8"	2"	1 1/16"	1"	1"
60-24HF9	60,000	9/16" O.D. TUBE	HF9	2 3/4"	2 5/8"	1 3/8"	1 5/16"	1 1/2"
40-24HF9	40,000	9/16" O.D. TUBE	HF9	2 3/4"	2 5/8"	1 3/8"	1 5/16"	1 1/2"
30-24HF16	30,000	1" O.D. TUBE	HF16	4 1/8"	4 1/8"	2 1/16"	2 1/16"	1 3/4"



## Union Couplings (Slip Type)

Union (slip Type) couplings are ideal for use in confined space installations. This design allows the entire coupling to be disconnected and slipped back over the tubing to facilitate assembly and disassembly. In installations where tubing is easily assembled, it is preferable (and less expensive) to use standard straight couplings (see accessories section). Standard material is high tensile 316 stainless steel. Standard tubing collars and glands are provided unless otherwise specified.

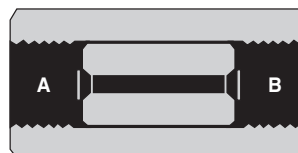

Catalog No.	Pressure Rating psi	Connections	A	B	Length	Hex Size
60-21HF2-U	60,000	1/8" O.D. TUBING	HF2	HF2	1 1/8"	3/4"
60-21HF4-U	60,000	1/4" O.D. TUBING	HF4	HF4	1 3/4"	1"
60-21HF6-U	60,000	3/8" O.D. TUBING	HF6	HF6	2"	1"
60-21HF9-U	60,000	9/16" O.D. TUBING	HF9	HF9	2 3/8"	1 3/8"
40-21HF9-U	40,000	9/16" O.D. TUBING	HF9	HF9	2 3/8"	1 3/8"
30-21HF16-U	30,000	1" O.D. TUBING	HF16	HF16	3 1/2"	1 3/4"

## Bulkhead Couplings

Bulkhead couplings are designed specifically for passing a tubing connection through a panel or steel barricade. These couplings include a locknut as shown. Material is high tensile 316 stainless steel. Standard tubing collars and glands are included unless otherwise specified.

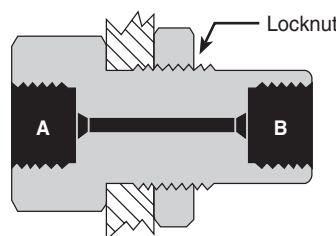

Catalog No.	Pressure Rating psi	Connections	Panel Hole	A	B	Length	Hex Size	Outside Thread
60-21HF2-B	60,000	1/8" O.D. TUBING	15/16"	HF2	HF2	1 13/16"	1"	7/8" - 14
60-21HF4-B	60,000	1/4" O.D. TUBING	15/16"	HF4	HF4	2"	1"	7/8" - 14
60-21HF6-B	60,000	3/8" O.D. TUBING	1 1/8"	HF6	HF6	2 3/8"	1 3/8"	1 1/16" - 12
60-21HF9-B	60,000	9/16" O.D. TUBING	1 11/16"	HF9	HF9	2 3/4"	1 7/8"	1 5/8" - 12
40-21HF9-B	40,000	9/16" O.D. TUBING	1 11/16"	HF9	HF9	2 3/4"	1 7/8"	1 5/8" - 12
30-21HF16-B	30,000	1" O.D. TUBING	1 15/16"	HF16	HF16	3 1/2"	1 7/8"	2 1/8" - 12

## Caps

Tubing end caps are offered for use in sealing off tubing ends either for temporary use or permanent use such as on small volume reservoirs. Standard material is high tensile 316 stainless steel. Standard tubing collars and glands are provided unless otherwise specified.

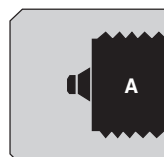

Catalog No.	Pressure Rating psi	Connections	A	Length	Hex Size
60-21HF2-C	60,000	1/8" O.D. TUBING	HF2	7/8"	3/4"
60-21HF4-C	60,000	1/4" O.D. TUBING	HF4	7/8"	3/4"
60-21HF6-C	60,000	3/8" O.D. TUBING	HF6	1 1/4"	1"
60-21HF9-C	60,000	9/16" O.D. TUBING	HF9	1 1/2"	1 3/8"
40-21HF9-C	40,000	9/16" O.D. TUBING	HF9	1 1/2"	1 3/8"
30-21HF16-C	30,000	1" O.D. TUBING	HF16	3"	1 3/4"



## High Pressure Equipment

### Line Filters

The line filters as shown utilize sintered stainless steel filter discs 3 pc./set. Porosities are available as per the chart to the right. If not otherwise specified, 100 micron filter discs are supplied. (One micron = 0.001 millimeters). Material of bodies and end covers is high tensile 316 stainless steel. Standard tubing glands and collars are provided unless otherwise specified.

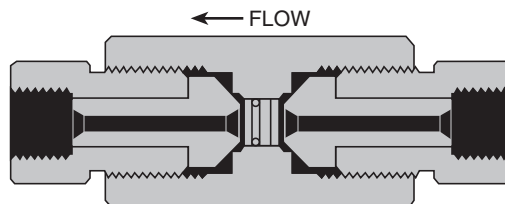

Catalog No.	Pressure Rating psi	Connections	Length	Hex Size	Micron Size Filter Available					
					0.5	2	5	10	40	100
40F-51HF9	40,000	9/16" HIGH PRESSURE	5 3/4"	1 1/2"	●	●	●	●	●	●
60F-51HF2	60,000	1/8" HIGH PRESSURE	4 11/16"	1 1/2"	●	●	●	●	●	●
60F-51HF4	60,000	1/4" HIGH PRESSURE	4 7/8"	1 1/2"	●	●	●	●	●	●
60F-51HF6	60,000	3/8" HIGH PRESSURE	5 1/4"	1 1/2"	●	●	●	●	●	●
60F-51HF9	60,000	9/16" HIGH PRESSURE	5 3/4"	1 1/2"	●	●	●	●	●	●

### Ball Check Valves

Ball type check valves insure flow in one direction only. Material for bodies and covers is 316 stainless steel (30-41HF16 body and cover are 17-4PH). Standard tubing glands and collars are provided unless otherwise specified.

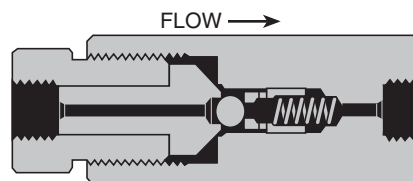

Catalog No.	psi	Connections	Length	Hex
40-41HF9	40,000	9/16" HIGH PRESSURE	5 1/8"	1 1/2"
60-41HF2	60,000	1/8" HIGH PRESSURE	4 3/16"	1 1/2"
60-41HF4	60,000	1/4" HIGH PRESSURE	4 1/4"	1 1/2"
60-41HF6	60,000	3/8" HIGH PRESSURE	4 5/8"	1 1/2"
60-41HF9	60,000	9/16" HIGH PRESSURE	5 1/8"	1 1/2"
30-41HF16	30,000	1" HIGH PRESSURE	6 1/2"	2 1/2" RD with flats

### Soft Seat Check Valves

Soft seat check valves insure flow in one direction only and can be mounted in any position. These are highly reliable for both gas and liquid service. Standard O-ring (soft seat) material for the sealing surface is Buna-N (nitrile) with other materials including Teflon and Viton available on request. Temperature is limited by the choice of O-ring material. Material of all other parts is high tensile 316 stainless steel. (30-41HF16-T body and cover are 17-4PH). Standard glands and collars are provided unless otherwise specified.

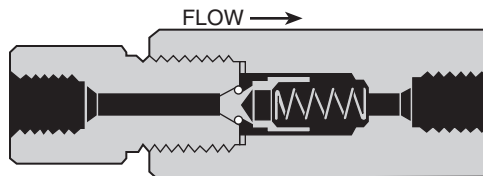

Catalog No.	psi	Connections	Length	Hex
30-41HF2-T	30,000	1/8" HIGH PRESSURE	3 3/4"	1"
30-41HF4-T	30,000	1/4" HIGH PRESSURE	3 7/8"	1"
30-41HF6-T	30,000	3/8" HIGH PRESSURE	3 7/8"	1"
30-41HF9-T	30,000	9/16" HIGH PRESSURE	4 1/4"	1 3/8"
40-41HF9-T	40,000	9/16" HIGH PRESSURE	5 1/16"	1 1/2"
60-41HF4-T	60,000	1/4" HIGH PRESSURE	4 9/16"	1 1/2"
60-41HF6-T	60,000	3/8" HIGH PRESSURE	4 9/16"	1 1/2"
60-41HF9-T	60,000	9/16" HIGH PRESSURE	5 1/16"	1 1/2"
30-41HF16-T	30,000	1" HIGH PRESSURE	6 1/2"	2 1/2" RD with flats

## Excess Surge Check Valves

Excess surge check valves are used to eliminate loss of pressure due to a sudden surge or opening of a pressure component in a pressurized system (such as a breakage of a gauge or test component). These check valves should be mounted in the vertical position. Only one basic size is available (60-41HF9-E) with adapters readily available to convert to other size connections. Standard tubing glands and collars are provided unless otherwise specified.

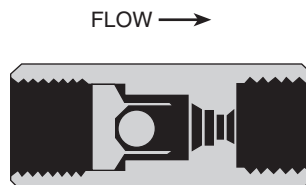

Catalog No.	psi	Connections	Length	Hex
60-41HF9-E	60,000	$\frac{9}{16}$ " HIGH PRESSURE	3 $\frac{1}{8}$ "	1 $\frac{1}{2}$ "

## Rupture Discs

### $\frac{1}{4}$ " Angled Seat

Standard rupture discs are available from stock in burst pressures as listed in the chart to the right. These discs are 316 stainless steel (except for 1000 psi which are inconel) and may be used with any of the safety heads shown. Note that these rupture discs are manufactured with a tolerance of plus 6% and minus 3% of specified burst pressure. Samples of each batch are then tested and the actual average burst pressure is stamped on the accompanying metal tag. Factors influencing rupture disc life include corrosion, metal fatigue, and cyclic effect. Periodic replacement is recommended to prevent premature failure. It is recommended that working pressure does not exceed 70% of burst rating for maximum life cycle of the disc.

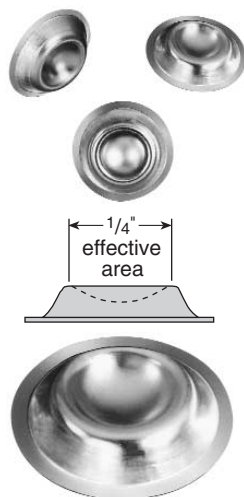

**SPECIAL DISCS** are available on special order for pressure ranges not shown above and in numerous materials and coatings. Consult factory for price and delivery.

### Standard Burst Pressures (in psi at 72°F)

1,000	3,000	5,000	7,000	9,000	11,000	17,500	25,000	37,500	55,000
1,500	3,500	5,500	7,500	9,500	11,500	18,000	27,000	40,000	60,000
2,000	4,000	6,000	8,000	10,000	12,500	20,000	30,000	45,000	65,000
2,500	4,500	6,500	8,500	10,500	15,000	22,500	35,000	50,000	



## High Pressure Equipment

### Safety Heads

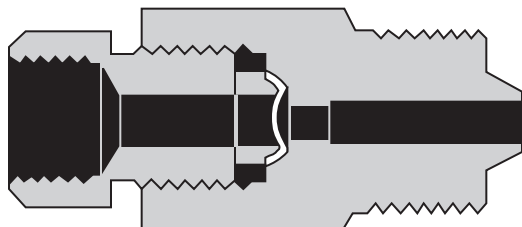

A choice of three safety head designs is available, male inlet, female inlet (straight), and tee type. The male inlet design can be inserted directly into the tubing connections of valves and various fittings such as tees and crosses, or located in pressure vessels.

Outlet connections on all sizes are  $\frac{3}{8}$ " pipe (NPT). This outlet may be connected to a suitable discharge line to vent pressure to a safe location in the event of bursting of the rupture disc. Torque required for sealing rupture discs will range from 40 to 90 foot pounds, depending upon pressure and media being used.

Material of bodies and hold down nuts is high tensile 316 stainless steel. Standard tubing glands and collars are provided unless otherwise specified.

**Note:** Rupture discs are **not** included and must be ordered as a separate item.



#### Male Inlet Safety Heads

Catalog No.	Pressure Rating psi	Inlet Connection	Length	Hex Size
60-61HM4	60,000	$\frac{1}{4}$ " HIGH PRESSURE	$1\frac{7}{8}$ "	$1\frac{1}{8}$ "
60-61HM6	60,000	$\frac{3}{8}$ " HIGH PRESSURE	$2\frac{1}{8}$ "	$1\frac{1}{8}$ "
60-61HM9	60,000	$\frac{9}{16}$ " HIGH PRESSURE	$2\frac{3}{8}$ "	$1\frac{1}{2}$ "
40-61HM9	40,000	$\frac{9}{16}$ " HIGH PRESSURE	$2\frac{3}{8}$ "	$1\frac{1}{2}$ "
30-61HM16	30,000	1" HIGH PRESSURE	$3\frac{1}{2}$ "	$1\frac{1}{8}$ "

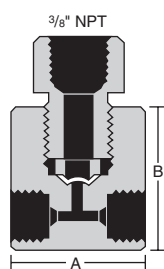

#### Tee Type Safety Heads

Catalog No.	Pressure Rating psi	Inlet Connection	A	B	Thickness
60-63HF2	60,000	$\frac{1}{8}$ " HIGH PRESSURE	$1\frac{1}{2}$ "	$1\frac{3}{4}$ "	1"
60-63HF4	60,000	$\frac{1}{4}$ " HIGH PRESSURE	$1\frac{1}{2}$ "	$1\frac{3}{4}$ "	1"
60-63HF6	60,000	$\frac{3}{8}$ " HIGH PRESSURE	2"	$1\frac{3}{4}$ "	1"
60-63HF9	60,000	$\frac{9}{16}$ " HIGH PRESSURE	$2\frac{5}{8}$ "	2"	$1\frac{1}{2}$ "
40-63HF9	40,000	$\frac{9}{16}$ " HIGH PRESSURE	2"	$2\frac{7}{8}$ "	$1\frac{1}{2}$ "



#### Female Inlet (Straight) Safety Heads

Catalog No.	Pressure Rating psi	Inlet Connection	Length	Hex Size
60-61HF2	60,000	$\frac{1}{8}$ " HIGH PRESSURE	$1\frac{7}{8}$ "	$1\frac{1}{8}$ "
60-61HF4	60,000	$\frac{1}{4}$ " HIGH PRESSURE	$1\frac{7}{8}$ "	$1\frac{1}{8}$ "
60-61HF6	60,000	$\frac{3}{8}$ " HIGH PRESSURE	$1\frac{7}{8}$ "	$1\frac{1}{8}$ "
60-61HF9	60,000	$\frac{9}{16}$ " HIGH PRESSURE	$2\frac{7}{8}$ "	$1\frac{1}{2}$ "
40-61HF9	40,000	$\frac{9}{16}$ " HIGH PRESSURE	$2\frac{3}{8}$ "	$1\frac{1}{2}$ "

## Anti-Vibration Gland Assemblies

Tubing systems that are subject to extreme vibration or shock, such as mobile pressure systems or long tubing runs culminating at a compressor, will benefit from the use of High Pressure Equipment Company's Anti-Vibration Gland Assemblies. These assemblies utilize the same reliable connection geometries as the standard HiP fittings, with the added benefit of essentially unlimited vibrational fatigue life.

A coned and threaded tube, when subjected to unusual or excessive vibration, may fail prematurely and break at the last thread. The Anti-Vibration Gland Assembly acts to move the fulcrum of vibration away from the threaded portion of the tube and onto the strong, solid wall of the tubing. A wedge-like collet firmly holds the assembly in place, virtually eliminating premature tubing failure while reliably maintaining a leak-free connection between the tube and the connection seat.

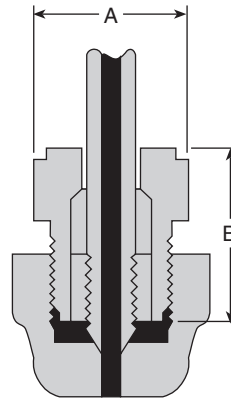

### High Pressure Anti-Vibration Gland Assemblies

Catalog No.	Pressure Rating psi	Connections	A	B
60-3HM4	60,000	1/4" HIGH PRESSURE	5/8"	13/16"
60-3HM6	60,000	3/8" HIGH PRESSURE	13/16"	1 1/8"
60-3HM9	60,000	9/16" HIGH PRESSURE	1 13/16"	1 9/16"
40-3HM9	40,000	9/16" HIGH PRESSURE	1 13/16"	1 9/16"

### Anti-Vibration Components

Tubing Size	Slotted Collet	Collet Gland	Collar
1/4"	2-8784	2-8783	60-2H4
3/8"	2-8786	2-8785	60-2H6
9/16"	2-8788	2-8787	60-2H9



## High Pressure Equipment

### High Pressure Tubing

Tubing is cold drawn, seamless, and is supplied in the  $\frac{1}{8}$ " hard condition (not annealed). Tensile strength is approximately 40 percent higher than that of annealed tubing. All tubing is manufactured in strict accordance with High Pressure Equipment Company specifications to insure tolerances and bore quality. Tubing is stocked in lengths of 18 to 22 feet but may be ordered in shorter lengths with **no additional cutting charge**.

**Note:** The  $\frac{1}{8}$ " O.D. tubing sizes may be coiled for shipment. Larger sizes must be shipped in straight lengths.

	Tubing Size	Working Pressure psi	Type of Connection Used	Material	Catalog Order Number
<b><math>\frac{1}{8}</math>"</b>	$\frac{1}{8}$ " O.D. x 0.020" I.D.	60,000	$\frac{1}{8}$ " HIGH PRESSURE (HF2)	316 SS	60-9H2
	$\frac{1}{8}$ " O.D. x 0.040" I.D.	30,000	$\frac{1}{8}$ " HIGH PRESSURE (HF2)	316 SS	30-9H2
<b><math>\frac{1}{4}</math>"</b>	$\frac{1}{4}$ " O.D. x 0.083" I.D.	60,000	$\frac{1}{4}$ " HIGH PRESSURE (HF4)	316 SS *	60-9H4-316
				304 SS *	60-9H4-304
<b><math>\frac{3}{8}</math>"</b>	$\frac{3}{8}$ " O.D. x $\frac{1}{8}$ " I.D.	60,000	$\frac{3}{8}$ " HIGH PRESSURE (HF6)	316 SS	60-9H6-316
				304 SS	60-9H6-304
<b><math>\frac{9}{16}</math>"</b>	$\frac{9}{16}$ " O.D. x $\frac{3}{16}$ " I.D.	60,000	$\frac{9}{16}$ " HIGH PRESSURE (HF9)	316 SS	60-9H9-316
				304 SS	60-9H9-304
<b><math>\frac{9}{16}</math>"</b>	$\frac{9}{16}$ " O.D. x $\frac{1}{4}$ " I.D.	40,000	$\frac{9}{16}$ " HIGH PRESSURE (HF9)	316 SS	40-9H9-316
				304 SS	40-9H9-304
<b>1"</b>	1" O.D. x 0.437" I.D.	30,000	1" HIGH PRESSURE (HF16)	316 SS	30-9H16-316

### Nipples

Nipples as shown below are stocked in Types 304 and 316 Stainless Steel. Nipples in lengths other than those shown are supplied upon request. Nipples are not furnished with collars and glands, unless specified at time of order.

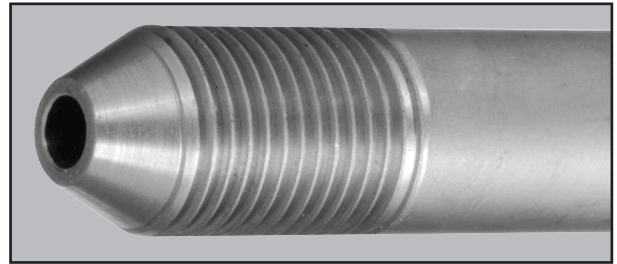

### Coned and Threaded Nipples

Length ↓	Tubing Size (O.D. x I.D.)						
	$\frac{1}{8}$ " x 0.020"	$\frac{1}{8}$ " x 0.040" **	$\frac{1}{4}$ " x 0.083"	$\frac{3}{8}$ " x $\frac{1}{8}$ " *	$\frac{9}{16}$ " x $\frac{3}{16}$ " **	$\frac{9}{16}$ " x $\frac{3}{16}$ " **	1" x 0.437" **
psi →	60,000 psi	30,000 psi	60,000 psi	60,000 psi	40,000 psi	60,000 psi	30,000 psi
2"	60-HM2-2	30-HM2-2					
2 $\frac{3}{4}$ "			60-HM4-2.75				
3"	60-HM2-3	30-HM2-3		60-HM6-3			
4"	60-HM2-4	30-HM2-4			40-HM9-4	60-HM9-4	
6"	60-HM2-6	30-HM2-6	60-HM4-6	60-HM6-6	40-HM9-6	60-HM9-6	30-HM16-6
8"			60-HM4-8	60-HM6-8	40-HM9-8	60-HM9-8	30-HM16-8
9"	60-HM2-9	30-HM2-9					
10"			60-HM4-10	60-HM6-10	40-HM9-10	60-HM9-10	30-HM16-10
12"	60-HM2-12	30-HM2-12	60-HM4-12	60-HM6-12	40-HM9-12	60-HM9-12	30-HM16-12

Specify 316 SS or 304 SS when ordering. \* Also used for 30,000 psi series. \*\* 316 SS



# High Pressure Connections

## (Coned and Threaded) 30,000/40,000/60,000 psi service

The High Pressure tubing connection is available for 1/8", 1/4", 3/8", 9/16" and 1" O.D. tubing. The tubing may be prepared with the use of tooling (see tooling section 9.0) or prepared at the factory to specified lengths. Additionally, standard length coned and threaded tubing nipples are available from stock (see page 4.12).

This connection has become an industry standard for use at elevated pressures and temperatures in both liquid and gas applications. It may be disassembled and retightened indefinitely.

The threads of the gland are right-hand while the threads of the collar and tubing are left-hand to prevent rotation of the collar during assembly.

**Materials.** All of the components required for make-up of a High Pressure connection (glands, collars and plugs) are produced in Type 316 stainless steel.

**Glands and collars** are provided with all valves and fittings (except nipples) unless otherwise requested. (See chart on the right for size details and catalog numbers).

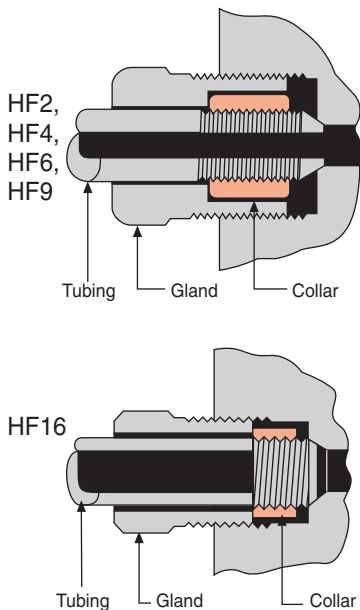

30,000 & 60,000 psi				40,000 psi	30,000 psi
HF2 1/8" O.D. Tubing	HF4 1/4" O.D. Tubing	HF6 3/8" O.D. Tubing	HF9 9/16" O.D. Tubing	HF9 9/16" O.D. Tubing	HF16 1" O.D. Tubing
<b>Female Opening Detail</b>					
HF2	HF4	HF6	HF9	HF9	HF16
<b>Gland</b>					
60-2HM2	60-2HM4	60-2HM6	60-2HM9	60-2HM9	30-2HM16
<b>Collar</b>					
60-2H2	60-2H4	60-2H6	60-2H9	60-2H9	30-2H16
<b>Plug</b>					
60-7HM2	60-7HM4	60-7HM6	60-7HM9	40-7HM9	30-7HM16
<b>Tube End Prep</b>					
HM2	HM4	HM6	HM9	HM9	HM16